

# ROUND L

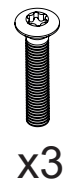

x3

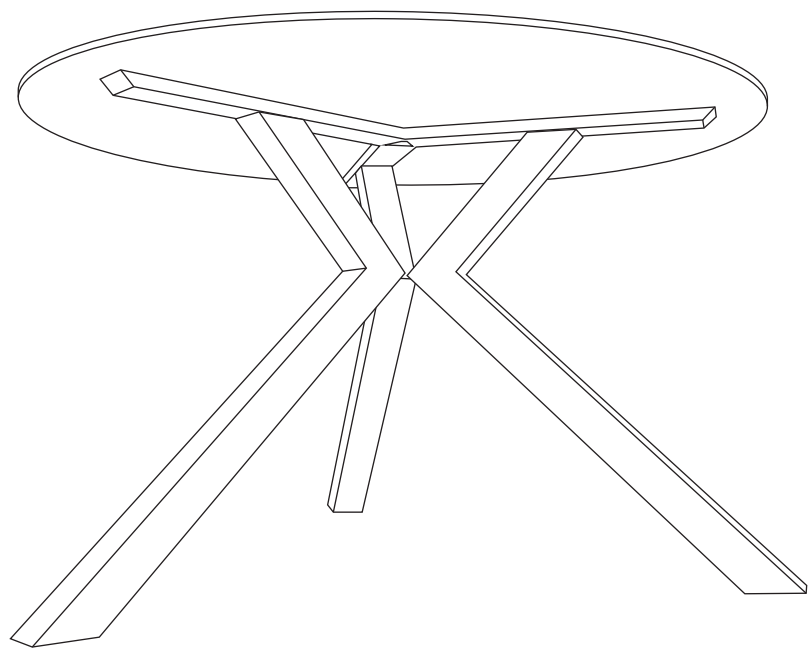
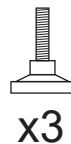

x3

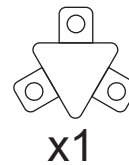

x1



x3



x3

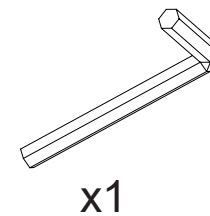

x1

- 1 Unimos las patas con la pieza central, los tornillos y las arandelas. Una vez atornilla retirar el protector del adhesivo.

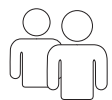
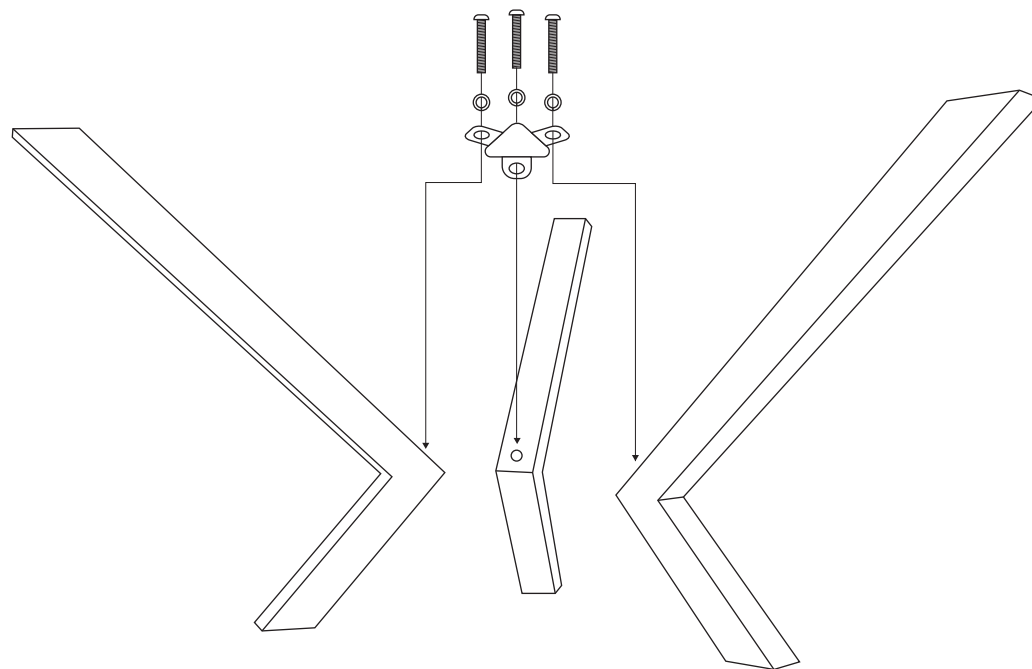
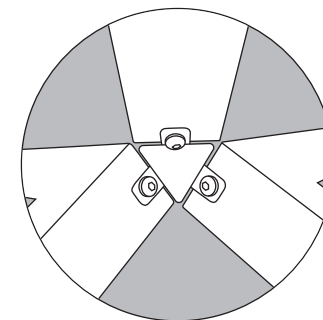

Se necesitan  
2 personas  
para el montaje

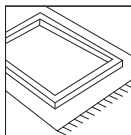

No apoyar ninguna  
pieza directamente  
en el suelo

**3** Girar la mesa y colocarla en pie.

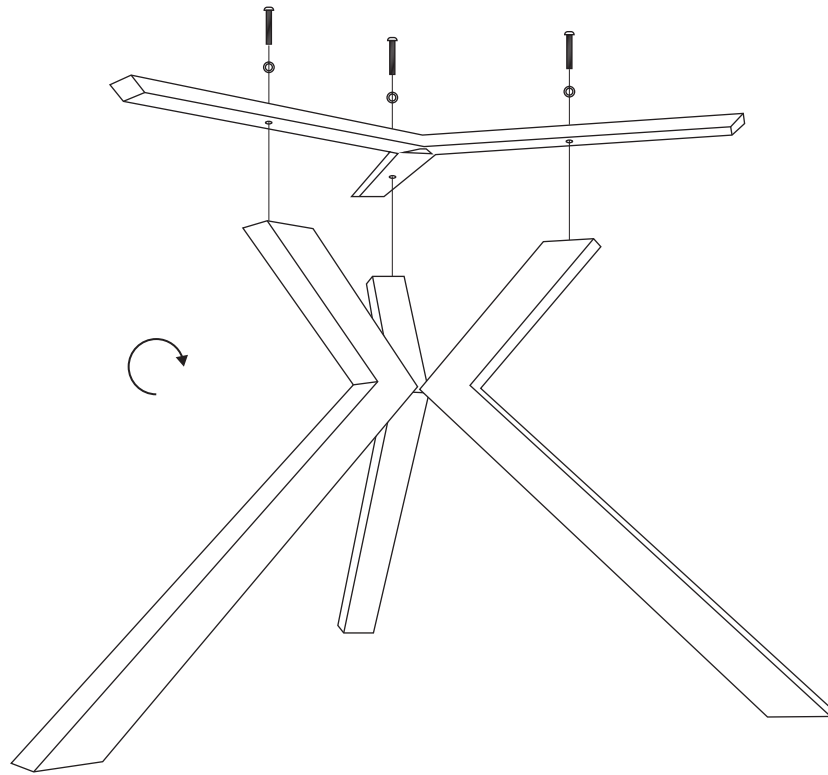

**4**

